

Krupp Hydraulic Truck-mounted Crane 500 ton Capacity

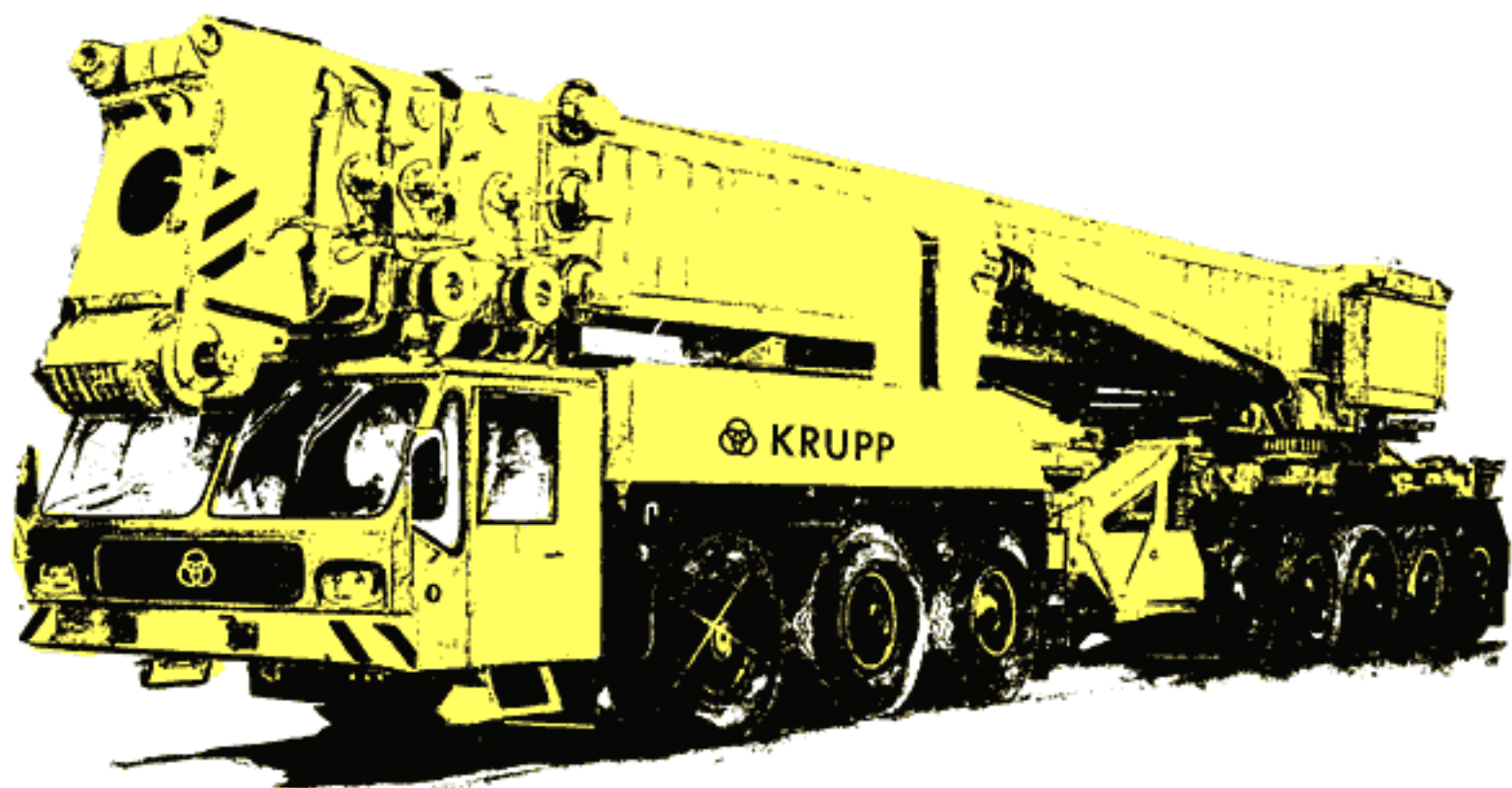

Dimensions

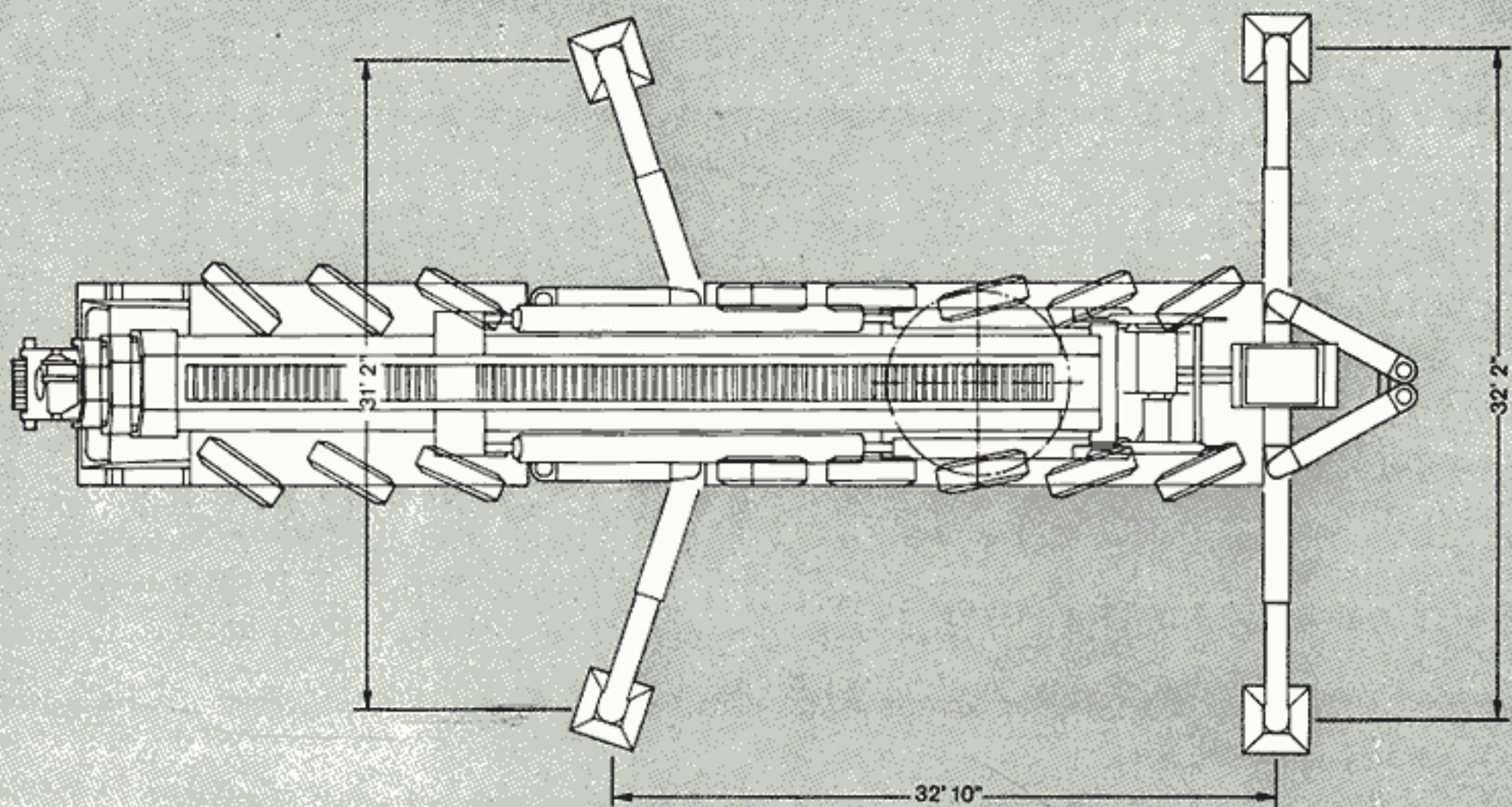
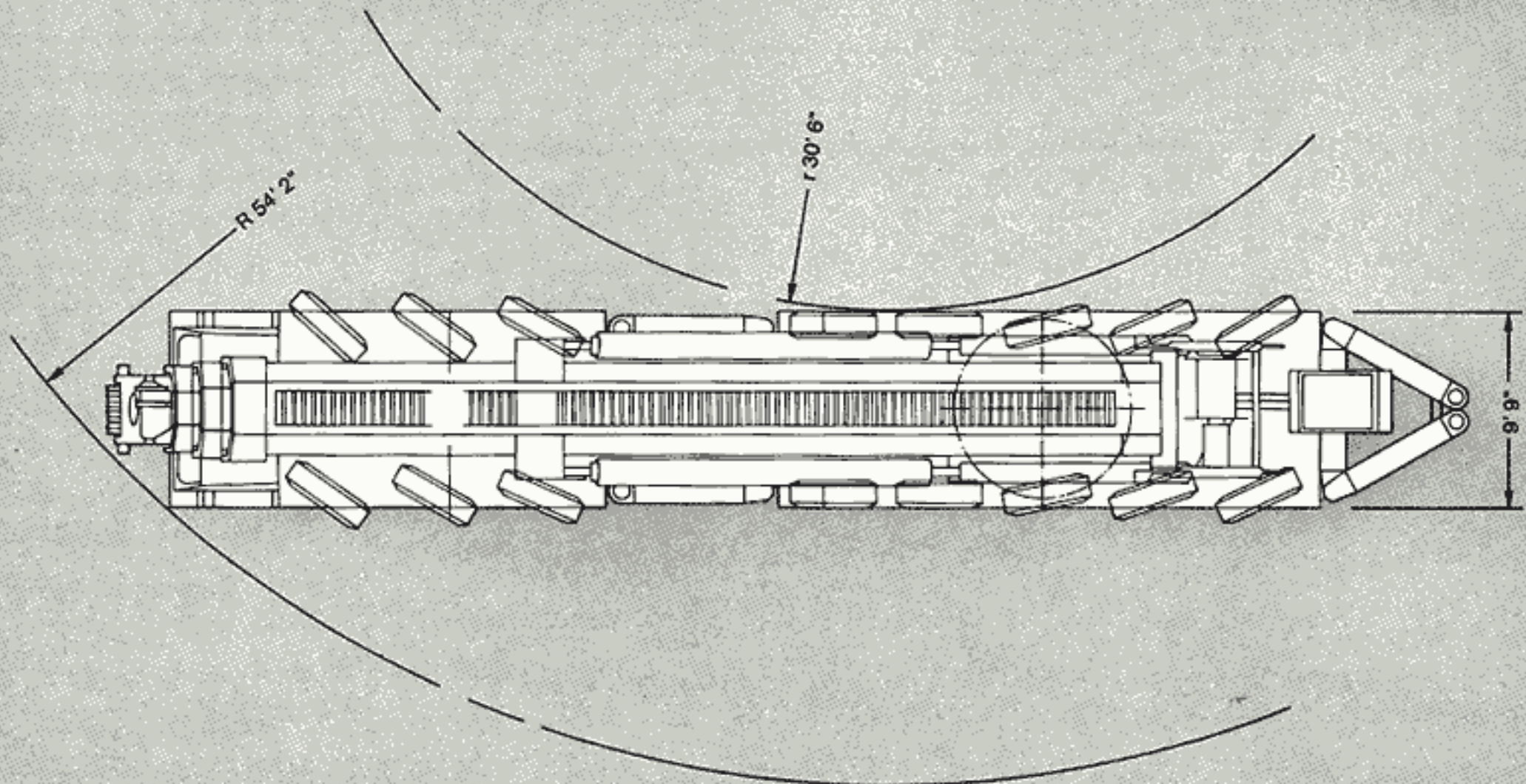
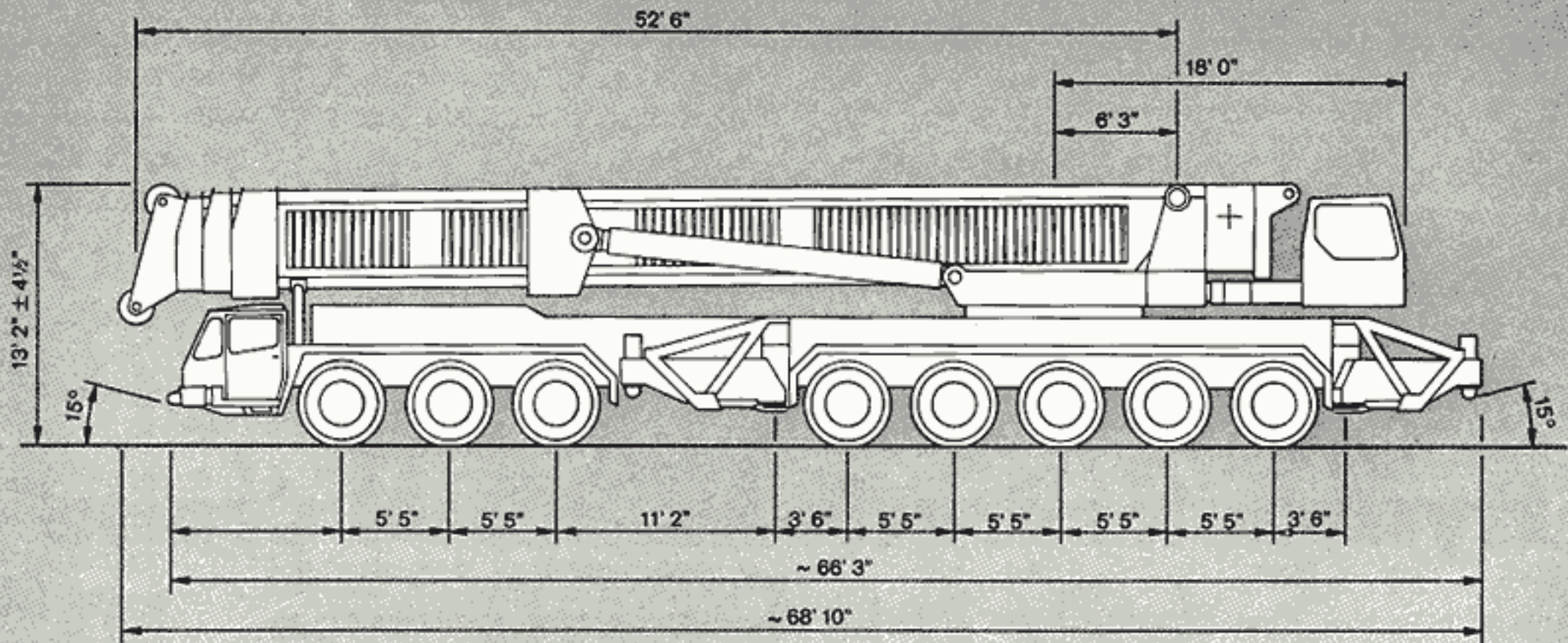

Hook Elevation Diagram

Main boom and lattice extension

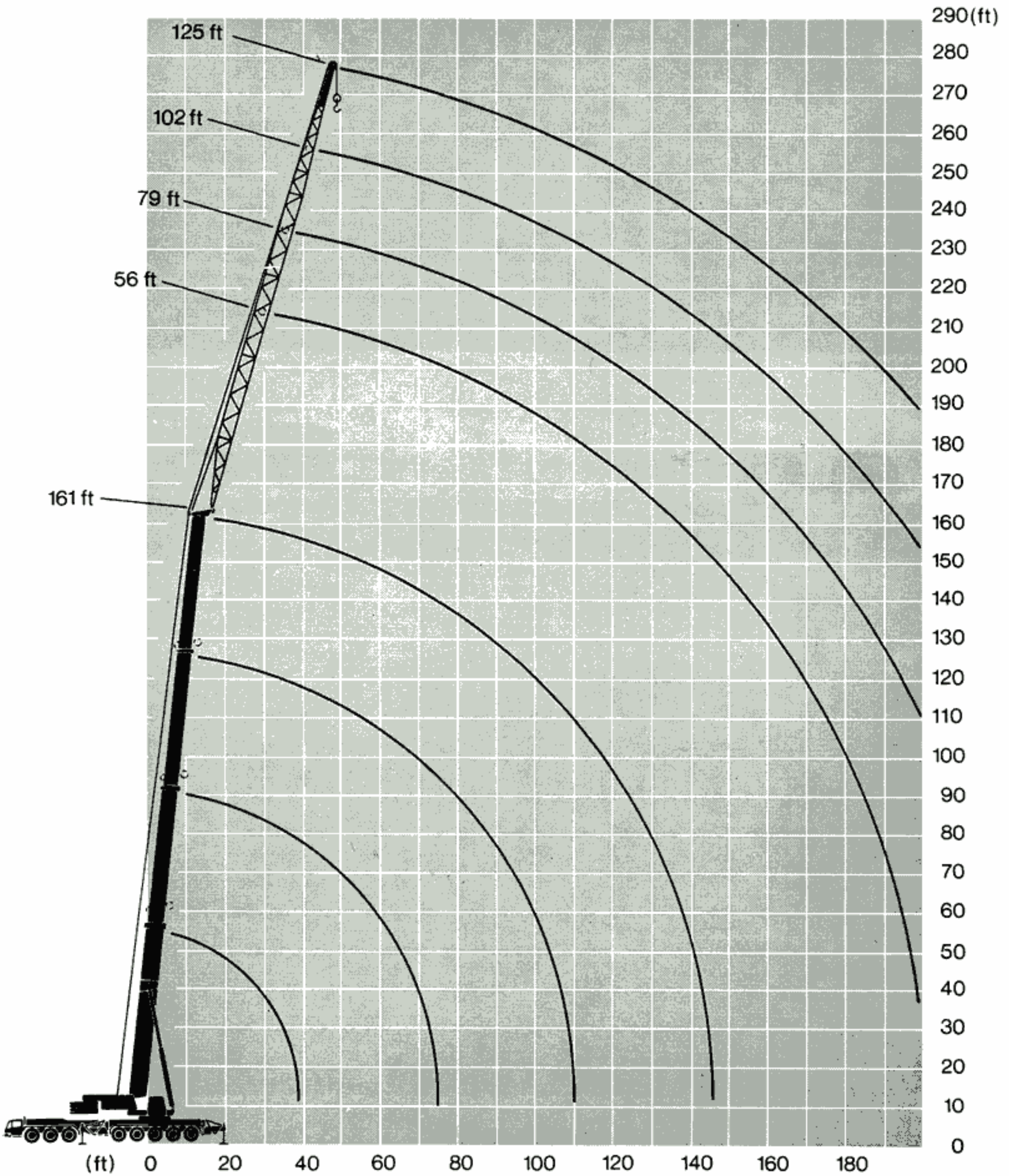

Main boom

Lifting capacities in 1000 lbs



53-107 ft



360°

92,6°

Counterweight

lbs

Radius ft	Boom length						Radius ft
	53 ft*	71 ft*	89 ft	89 ft	107 ft	107 ft	
10	744.0						10
11	710.0						11
12	677.0						12
13	643.0	582.0	507.0	388.0			13
14	615.0	554.0	489.0	379.0			14
15	588.0	522.0	469.0	369.0			15
20	482.0	407.0	388.0	328.0		329.0	20
25	357.0	329.0	330.0	297.0	281.0	289.0	25
30	242.0	233.0	281.0	268.0	247.0	255.0	30
35	187.0	174.0	229.0	236.0	218.0	222.0	35
40	134.0	132.0	179.0	194.0	187.0	177.0	40
45		104.0	144.0	157.0	152.0	142.0	45
50		85.9	118.0	130.0	124.0	116.0	50
55		71.1	98.3	109.0	103.0	96.6	55
60		58.3	82.4	93.4	87.5	80.8	60
65			69.5	80.7	76.1	68.5	65
70			59.8	70.3	66.2	58.3	70
75			51.3	61.4	57.4	49.6	75
80					49.7	42.3	80
85					43.3	36.0	85
90					37.9	30.8	90
95					33.0	26.2	95
T1	0	50	50	0	50	100	T1
T2	0	0	50	50	50	50	T2
T3	0	0	0	50	50	0	T3

*outrigger base 25' 6"/26' 3" x 31' 10".

*1000 lbs



125-161 ft



360°

92,6°

Counterweight

lbs

Radius ft	Boom length					Radius ft
	125 ft	125 ft	143 ft	143 ft	161 ft	
20	292.0	225.0				20
25	253.0	194.0	191.0	210.0	174.0	25
30	222.0	172.0	168.0	192.0	162.0	30
35	197.0	157.0	152.0	177.0	152.0	35
40	174.0	144.0	140.0	161.0	141.3	40
45	143.0	134.0	131.0	145.0	131.0	45
50	118.0	125.0	122.0	122.0	120.0	50
55	98.2	112.0	109.0	100.0	105.0	55
60	82.0	96.1	92.5	85.0	89.1	60
65	69.6	83.1	79.6	73.3	76.5	65
70	59.5	72.7	69.5	63.3	66.4	70
75	50.9	63.8	60.8	54.6	57.6	75
80	43.5	56.3	53.2	47.1	49.9	80
85	37.2	49.7	46.6	40.7	43.6	85
90	31.9	44.4	41.2	35.2	38.1	90
95	27.2	39.6	36.4	30.5	33.4	95
100	23.0	35.1	32.1	26.3	29.2	100
105	19.3	31.3	28.4	22.4	25.5	105
110	16.2	27.9	25.0	19.4	22.2	110
115			22.0	16.5	19.1	115
120			19.3	13.8	16.5	120
125			16.8	11.5	14.1	125
130			14.6	9.3	12.0	130
135					10.0	135
140					8.2	140
145					6.3	145
T1	100	0	50	100	100	T1
T2	100	100	100	100	100	T2
T3	0	100	100	50	100	T3

*1000 lbs



Main boom

Lifting capacities in 1000 lbs



53-89 ft



360°

Counterweight

198,4*

lbs

Radius		Boom length					Radius
ft		53 ft*	53 ft**	71 ft**	89 ft	89 ft	ft
10		1000.0	744.0				10
11		884.0	710.0				11
12		810.0	677.0				12
13		736.0	643.0	582.0	507.0	388.0	13
14		695.0	615.0	557.0	489.0	379.0	14
15		658.0	588.0	529.0	469.0	369.0	15
20		538.0	484.0	407.0	388.0	328.0	20
25		446.0	410.0	343.0	330.0	297.0	25
30		369.0	352.0	307.0	283.0	268.0	30
35		317.0	302.0	285.0	252.0	246.0	35
40		267.0	248.0	245.0	221.0	226.0	40
45				202.0	198.0	204.0	45
50				169.0	178.0	185.0	50
55				143.0	162.0	168.0	55
60				121.0	146.0	153.0	60
65					125.0	136.0	65
70					111.0	121.0	70
75					99.1	108.0	75
	T1	0	0	50	50	0	T1
	T2	0	0	0	50	50	T2
	T3	0	0	0	0	50	T3

* outrigger base 25' 6"/26' 3" x 31' 10" with heavy-duty equipment.

** outrigger base 25' 6"/26' 3" x 31' 10".

*1000 lbs



107-161 ft



360°

Counterweight

198,4*

lbs

Radius		Boom length						Radius	
ft		107 ft	107 ft	125 ft	125 ft	143 ft	143 ft	161 ft	ft
20			336.0	292.0	225.0				20
25		285.0	292.0	255.0	194.0	191.0	210.0	174.0	25
30		250.0	255.0	222.0	172.0	168.0	192.0	162.0	30
35		222.0	231.0	197.0	157.0	152.0	177.0	155.0	35
40		202.0	209.0	176.0	144.0	140.0	161.0	150.0	40
45		184.0	205.0	161.0	134.0	131.0	149.0	133.0	45
50		165.0	180.0	147.0	130.0	125.0	136.0	121.0	50
55		149.0	157.0	136.0	124.0	120.0	125.0	112.0	55
60		137.0	143.0	128.0	113.0	113.0	115.0	104.0	60
65		128.0	133.0	118.0	108.0	108.0	106.0	97.8	65
70		114.0	119.0	109.0	103.0	103.0	99.9	91.1	70
75		106.0	105.0	98.2	96.6	96.6	92.2	85.3	75
80		101.0	94.4	86.0	88.7	88.7	84.7	80.3	80
85		91.0	84.3	77.6	81.9	81.9	79.6	75.2	85
90		82.5	75.8	69.2	75.2	75.2	76.2	71.8	90
95		70.9	64.3	62.9	68.5	68.5	70.7	67.3	95
100				59.0	62.8	62.8	64.5	62.3	100
105				57.3	59.5	59.5	59.5	57.3	105
110				52.2	57.8	54.4	54.4	55.6	110
115						47.1	50.5	52.8	115
120						41.2	46.6	48.8	120
125						39.5	41.6	43.8	125
130						37.8	38.3	40.5	130
135								37.1	135
140								34.5	140
145								32.6	145
150								29.2	150
	T1	50	100	100	0	50	100	100	T1
	T2	50	50	100	100	100	100	100	T2
	T3	50	0	0	100	100	50	100	T3

*1000 lbs



KMK 8400

Main boom + lattice extension

Lifting capacities in 1000 lbs



56-125 ft



360°

198,4*

Counterweight lbs

Radius ft	Main boom length 161 ft				Radius ft
	56 ft	79 ft	102 ft	125 ft	
45	52.9				45
50	51.5				50
55	50.7				55
60	50.3	40.4			60
65	48.7	38.7			65
70	47.0	37.8			70
75	45.3	36.5	30.4		75
80	43.6	35.0	28.5		80
85	41.9	34.2	26.5	21.6	85
90	38.7	33.3	25.3	20.8	90
95	36.4	32.3	24.6	20.1	95
100	35.0	31.1	24.0	19.7	100
105	34.1	29.9	23.3	19.4	105
110	32.1	28.3	22.5	18.7	110
115	29.4	26.7	21.6	18.0	115
120	27.2	25.0	20.7	17.1	120
125	26.4	23.0	19.7	16.0	125
130	25.5	21.3	18.9	14.8	130
135	24.7	20.6	17.9	14.0	135
140	23.8	20.2	17.1	13.1	140
145	23.0	19.7	16.3	12.0	145
150	22.2	18.8	14.8	10.9	150
155	20.6	18.0	13.7	10.3	155
160	19.4	17.3	13.1	9.9	160
165		16.8	12.8	9.5	165
170		15.9	11.8	8.9	170
175		15.2	11.2	8.5	175
180		14.5	10.8	8.0	180
185		13.7	10.5	7.3	185
190		13.2	10.1	6.6	190
195		12.4	9.8	6.1	195
T 1	100	100	100	100	T 1
T 2	100	100	100	100	T 2
T 3	100	100	100	100	T 3

*1000 lbs

Hook Elevation Diagram

Luffing Jib

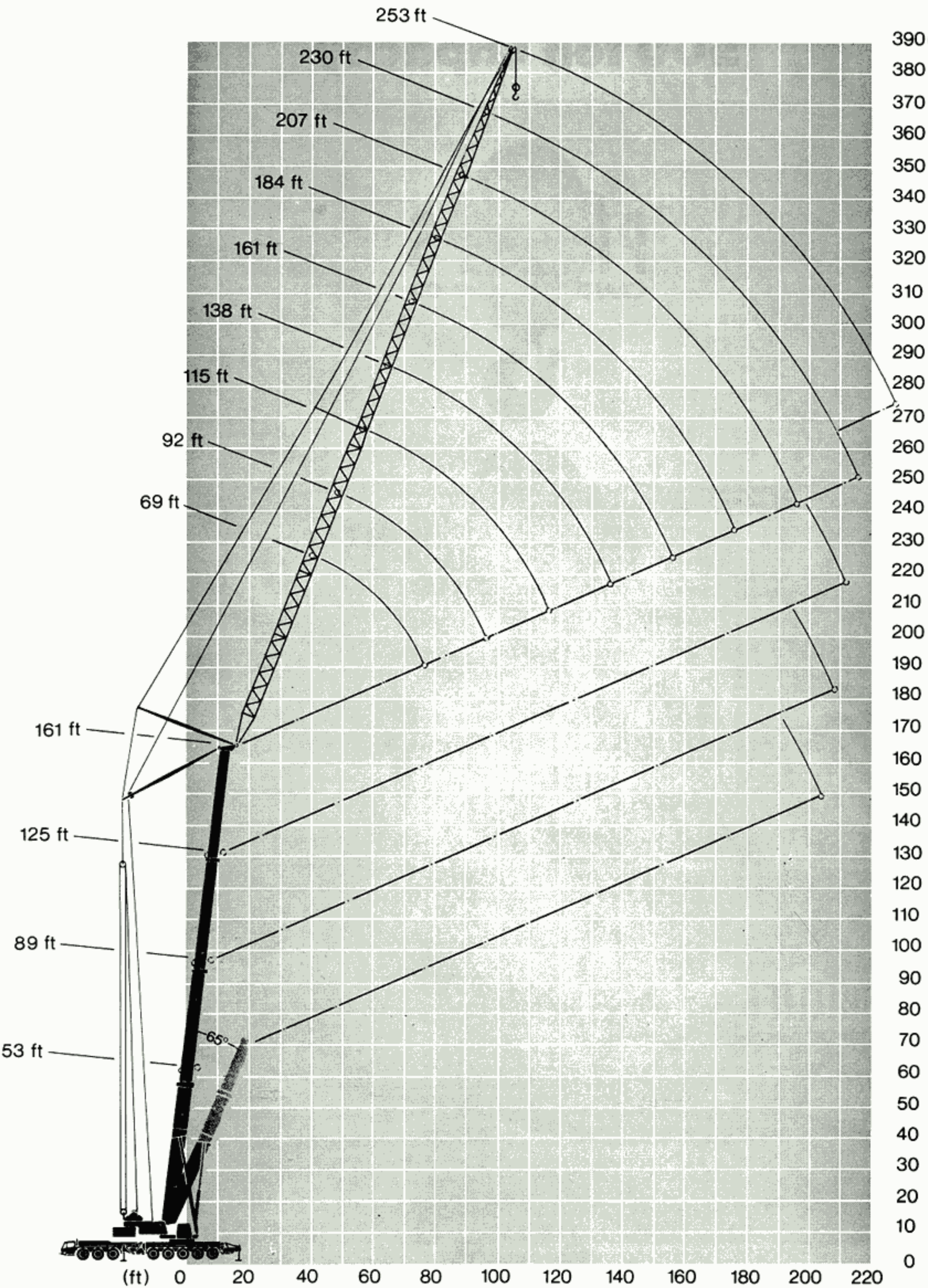

Main boom + luffing fly jib

Lifting capacities in 1000 lbs

MAIN BOOM AT 84° ANGLE



69 ft



360°

Counterweight

198,4*

lbs

Radius ft	Main boom length at 84°							Radius ft
	53 ft	71 ft	89 ft	107 ft	125 ft	143 ft	161 ft	
40	239.0	215.0	200.0	161.0	123.0			40
45	210.0	197.0	190.0	156.0	123.0	92.0	63.0	45
50	194.0	148.0	178.0	149.0	120.0	90.0	63.0	50
55	181.0	172.0	167.0	142.0	117.0	88.0	63.0	55
60	170.0	161.0	158.0	136.0	116.0	87.0	63.0	60
65	163.0	153.0	146.0	129.0	114.0	85.0	63.0	65
70			137.0	123.0	112.0	82.0	63.0	70
75							63.0	75
T1	0	50	50	100	100	100	100	T1
T2	0	0	50	50	100	100	100	T2
T3	0	0	0	0	0	50	100	T3

*1000 lbs



92 ft



360°

Counterweight

198,4*

lbs

Radius ft	Main boom length at 84°							Radius ft
	53 ft	71 ft	89 ft	107 ft	125 ft	143 ft	161 ft	
40	216.0							40
45	199.0	174.0	152.0	123.0	97.0			45
50	187.0	167.0	148.0	122.0	97.0			50
55	177.0	158.0	141.0	119.0	97.0	75.0	53.0	55
60	167.0	151.0	134.0	115.0	96.0	74.0	53.0	60
65	154.0	141.0	129.0	112.0	94.0	73.0	51.0	65
70	143.0	132.0	123.0	108.0	94.0	72.0	51.0	70
75	132.0	124.0	118.0	105.0	94.0	72.0	50.0	75
80	121.0	116.0	111.0	102.0	94.0	72.0	50.0	80
85	112.0	105.0	100.0	97.0	92.0	70.0	48.0	85
90		100.0	99.0	95.0	92.0	70.0	48.0	90
95							48.0	95
T1	0	50	50	100	100	100	100	T1
T2	0	0	50	50	100	100	100	T2
T3	0	0	0	0	0	50	100	T3

*1000 lbs



115 ft



360°

Counterweight

198,4*

lbs

Radius ft	Main boom length at 84°							Radius ft
	53 ft	71 ft	89 ft	107 ft	125 ft	143 ft	161 ft	
45	138.0							45
50	138.0							50
55	135.0	122.0	111.0	92.0	72.0			55
60	129.0	120.0	110.0	91.0	72.0	53.0		60
65	124.0	114.0	107.0	90.0	72.0	53.0	36.0	65
70	118.0	110.0	103.0	88.0	72.0	53.0	36.0	70
75	113.0	106.0	99.0	86.0	72.0	53.0	36.0	75
80	108.0	100.0	96.0	84.0	72.0	53.0	36.0	80
85	104.0	97.0	92.0	82.0	72.0	53.0	36.0	85
90	99.0	93.0	88.0	80.0	72.0	53.0	36.0	90
95	93.0	88.0	85.0	78.0	71.0	52.0	36.0	95
100	88.0	83.0	81.0	77.0	70.0	50.0	36.0	100
105	82.0	80.0	80.0	75.0	70.0	50.0	36.0	105
110	82.0	78.0	76.0	73.0	70.0	49.0	36.0	110
115			73.0	71.0	70.0	48.0	36.0	115
T1	0	50	50	100	100	100	100	T1
T2	0	0	50	50	100	100	100	T2
T3	0	0	0	0	0	50	100	T3

*1000 lbs



Main boom + luffing fly jib

Lifting capacities in 1000 lbs



138 ft



360°

198,4*

Counterweight

lbs

Radius ft	Main boom length at 84°							Radius ft
	53 ft	71 ft	89 ft	107 ft	125 ft	143 ft	161 ft	
55	104.0							55
60	103.0	94.0	84.0	70.0	55.0			60
65	99.0	92.0	84.0	70.0	55.0	41.0		65
70	97.0	88.0	81.0	68.0	55.0	41.0		70
75	94.0	86.0	79.0	66.0	54.0	41.0	29.0	75
80	91.0	84.0	77.0	65.0	53.0	41.0	29.0	80
85	87.0	80.0	75.0	63.0	53.0	41.0	29.0	85
90	85.0	78.0	73.0	61.0	53.0	41.0	29.0	90
95	82.0	76.0	71.0	60.0	53.0	41.0	29.0	95
100	78.0	74.0	69.0	60.0	52.0	38.0	29.0	100
105	75.0	72.0	67.0	58.0	50.0	38.0	29.0	105
110	73.0	69.0	64.0	56.0	50.0	38.0	29.0	110
115	70.0	65.0	61.0	55.0	50.0	37.0	27.0	115
120	65.0	61.0	59.0	55.0	50.0	36.0	26.0	120
125	60.0	58.0	58.0	53.0	50.0	36.0	26.0	125
130	60.0	58.0	56.0	51.0	49.0	34.0	26.0	130
135			55.0	50.0	48.0	34.0	26.0	135
140							26.0	140
145							26.0	145
T1	0	50	50	100	100	100	100	T1
T2 %	0	0	50	50	100	100	100	T2 %
T3	0	0	0	0	0	50	100	T3

*1000 lbs



161 ft



360°

198,4*

Counterweight

lbs

Radius ft	Main boom length at 84°							Radius ft
	53 ft	71 ft	89 ft	107 ft	125 ft	143 ft	161 ft	
60	82.0							60
65	82.0	75.0	67.0	55.0	46.0			65
70	80.0	73.0	67.0	55.0	46.0			70
75	79.0	71.0	66.0	55.0	46.0	34.0	21.0	75
80	77.0	69.0	65.0	55.0	46.0	34.0	21.0	80
85	75.0	68.0	63.0	53.0	46.0	34.0	21.0	85
90	73.0	66.0	61.0	53.0	46.0	34.0	21.0	90
95	71.0	64.0	59.0	52.0	46.0	34.0	21.0	95
100	69.0	62.0	57.0	50.0	45.0	33.0	21.0	100
105	67.0	60.0	55.0	50.0	43.0	31.0	23.1	105
110	66.0	60.0	55.0	49.0	43.0	31.0	21.0	110
115	64.0	59.0	54.0	48.0	43.0	31.0	21.0	115
120	61.0	57.0	53.0	48.0	43.0	31.0	21.0	120
125	58.0	55.0	53.0	48.0	43.0	31.0	21.0	125
130	56.0	53.0	51.0	46.0	43.0	31.0	19.0	130
135	54.0	52.0	49.0	44.0	42.0	30.0	19.0	135
140	52.0	50.0	47.0	43.0	41.0	29.0	19.0	140
145	50.0	48.0	46.0	43.0	41.0	29.0	19.0	145
150	48.0	46.0	46.0	43.0	41.0	29.0	19.0	150
155			44.0	42.0	41.0	29.0	19.0	155
160					41.0	29.0	18.0	160
T1	0	50	50	100	100	100	100	T1
T2 %	0	0	50	50	100	100	100	T2 %
T3	0	0	0	0	0	50	100	T3

*1000 lbs

Main boom + luffing fly jib

Lifting capacities in 1000 lbs



184 ft





360°

198,4°

Counterweight **lbs**

Radius ft	Main boom length at 84°							Radius ft
	53 ft	71 ft	89 ft	107 ft	125 ft	143 ft	161 ft	
65	63.0	00						65
70	63.0							70
75	62.0	57.0	52.0	42.0	34.0			75
80	60.0	55.0	50.0	41.0	34.0	24.0	17.0	80
85	60.0	53.0	50.0	41.0	34.0	24.0	17.0	85
90	58.0	53.0	49.0	41.0	34.0	24.0	17.0	90
95	57.0	53.0	48.0	41.0	34.0	24.0	17.0	95
100	55.0	52.0	47.0	40.0	34.0	24.0	17.0	100
105	55.0	50.0	46.0	38.0	34.0	24.0	17.0	105
110	53.0	49.0	46.0	38.0	34.0	24.0	17.0	110
115	52.0	48.0	46.0	38.0	34.0	24.0	17.0	115
120	50.0	47.0	45.0	38.0	34.0	24.0	17.0	120
125	50.0	46.0	43.0	38.0	34.0	24.0	17.0	125
130	49.0	46.0	43.0	38.0	34.0	24.0	17.0	130
135	47.0	44.0	42.0	37.0	34.0	24.0	17.0	135
140	46.0	43.0	41.0	36.0	34.0	24.0	17.0	140
145	45.0	43.0	41.0	36.0	34.0	24.0	17.0	145
150	44.0	43.0	41.0	36.0	34.0	24.0	17.0	150
155	42.0	42.0	39.0	36.0	34.0	24.0	17.0	155
160	41.0	40.0	38.0	36.0	34.0	24.0	17.0	160
165	40.0	38.0	38.0	36.0	34.0	24.0	17.0	165
170	39.0	36.0	36.0	34.0	34.0	24.0	17.0	170
175			36.0	34.0	34.0	24.0	17.0	175
180						24.0	16.0	180
T 1	0	50	50	100	100	100	100	T 1
T 2	0	0	50	50	100	100	100	T 2
T 3	0	0	0	0	0	50	100	T 3

*1000 lbs



207 ft





360°

198,4°

Counterweight **lbs**

Radius ft	Main boom length at 84°							Radius ft
	53 ft	71 ft	89 ft	107 ft	125 ft	143 ft	161 ft	
80	48.0	41.0	38.0	31.0	24.0			80
85	46.0	41.0	38.0	31.0	24.0	17.0	12.0	85
90	46.0	41.0	38.0	31.0	24.0	17.0	12.0	90
95	44.0	40.0	38.0	31.0	24.0	17.0	12.0	95
100	43.0	38.0	38.0	31.0	24.0	17.0	12.0	100
105	43.0	38.0	38.0	31.0	24.0	17.0	12.0	105
110	43.0	38.0	38.0	31.0	24.0	17.0	12.0	110
115	42.0	38.0	38.0	31.0	24.0	17.0	12.0	115
120	41.0	38.0	38.0	31.0	24.0	17.0	12.0	120
125	41.0	38.0	38.0	31.0	24.0	17.0	12.0	125
130	39.0	36.0	36.0	29.0	24.0	17.0	12.0	130
135	38.0	36.0	36.0	29.0	24.0	17.0	12.0	135
140	38.0	36.0	35.0	29.0	24.0	17.0	12.0	140
145	38.0	36.0	34.0	29.0	24.0	17.0	12.0	145
150	38.0	36.0	34.0	29.0	24.0	17.0	12.0	150
155	37.0	34.0	34.0	29.0	24.0	17.0	12.0	155
160	36.0	34.0	34.0	29.0	24.0	17.0	12.0	160
165	36.0	33.0	33.0	28.0	24.0	17.0	12.0	165
170	34.0	31.0	31.0	26.0	24.0	17.0	12.0	170
175	34.0	31.0	31.0	26.0	24.0	17.0	12.0	175
180	34.0	31.0	31.0	26.0	24.0	17.0	12.0	180
185	34.0	31.0	31.0	26.0	24.0	17.0	12.0	185
190	34.0	31.0	29.0	26.0	24.0	17.0	12.0	190
195	32.0	29.0	29.0	26.0	24.0	17.0	12.0	195
200			29.0	26.0	24.0	17.0	12.0	200
205					24.0	17.0	12.0	205
210					24.0	17.0	12.0	210
T 1	0	50	50	100	100	100	100	T 1
T 2	0	0	50	50	100	100	100	T 2
T 3	0	0	0	0	0	50	100	T 3

*1000 lbs

Main boom + luffing fly jib

Lifting capacities in 1000 lbs



230 ft



360°

198,4*

Counterweight

lbs

Radius ft	Main boom length at 84°							Radius ft
	53 ft	71 ft	89 ft	107 ft	125 ft	143 ft	161 ft	
75	34.0							75
80	34.0	31.0	31.0					95
85	34.0	31.0	31.0	26.0	19.0			85
90	34.0	31.0	31.0	26.0	19.0			90
95	34.0	31.0	31.0	26.0	19.0	14.5	9.7	95
100	34.0	31.0	31.0	26.0	19.0	14.5	9.7	100
105	34.0	31.0	31.0	24.0	19.0	14.5	9.7	105
110	34.0	31.0	31.0	24.0	19.0	14.5	9.7	110
115	32.0	30.0	30.0	24.0	19.0	14.5	9.7	115
120	31.0	29.0	29.0	24.0	19.0	14.5	9.7	120
125	31.0	29.0	29.0	24.0	19.0	14.5	9.7	125
130	31.0	29.0	29.0	24.0	19.0	14.5	9.7	130
135	31.0	29.0	29.0	24.0	19.0	14.5	9.7	135
140	31.0	29.0	29.0	24.0	19.0	14.5	9.7	140
145	31.0	29.0	29.0	24.0	19.0	14.5	9.7	145
150	31.0	29.0	29.0	24.0	19.0	14.5	9.7	150
155	31.0	29.0	29.0	22.0	17.0	13.0	9.7	155
160	31.0	29.0	29.0	21.0	17.0	12.0	9.7	160
165	31.0	29.0	29.0	21.0	17.0	12.0	9.7	165
170	29.0	29.0	29.0	21.0	17.0	12.0	9.7	170
175	29.0	29.0	29.0	21.0	17.0	12.0	9.7	175
180	29.0	29.0	29.0	21.0	17.0	12.0	9.7	180
185	29.0	28.0	28.0	21.0	17.0	12.0	9.7	185
190	29.0	26.0	26.0	21.0	17.0	12.0	9.7	190
195	29.0	26.0	26.0	21.0	17.0	12.0	9.7	195
200	28.0	26.0	26.0	21.0	17.0	12.0	9.7	200
205	26.0	26.0	26.0	21.0	17.0	12.0	9.7	205
210	26.0	26.0	26.0	21.0	17.0	12.0	9.7	210
215	26.0	26.0	26.0	21.0	17.0	12.0	9.7	215
220			26.0	21.0	17.0	12.0	9.7	210
225					17.0	12.0	9.7	225
230					17.0	12.0	9.7	210
T1	0	50	50	100	100	100	100	T1
T2	0	0	50	50	100	100	100	T2
T3	0	0	0	0	0	50	100	T3

*1000 lbs



253 ft



360°

198,4*

Counterweight

lbs

Radius ft	Main boom length at 84°							Radius ft
	53 ft	71 ft	89 ft	107 ft	125 ft	143 ft	161 ft	
105	24.0	21.0						105
110	24.0	21.0						110
115	24.0	21.0	19.0	15.5	12.0			115
120	24.0	21.0	19.0	15.5	12.0	9.5		120
125	24.0	21.0	19.0	15.5	12.0	9.5		125
130	24.0	21.0	19.0	15.5	12.0	8.5		130
135	24.0	21.0	19.0	15.5	12.0	8.5		135
140	24.0	21.0	19.0	15.5	12.0	8.5		140
145	24.0	21.0	19.0	15.5	12.0	8.5		145
150	24.0	21.0	19.0	15.5	12.0	8.5		150
155	24.0	21.0	19.0	15.5	12.0	8.5		155
160	24.0	21.0	19.0	15.5	12.0	8.5		160
165	24.0	21.0	19.0	15.5	12.0	8.5		165
170	23.0	21.0	19.0	15.5	12.0	8.5		170
175	22.0	21.0	19.0	15.5	12.0	8.5		175
180	21.0	21.0	19.0	15.5	12.0	8.5		180
185	21.0	21.0	19.0	15.5	12.0	8.5		185
190	21.0	21.0	18.0	15.5	12.0	8.5		190
195	20.0	20.0	18.0	15.5	12.0	8.5		195
200	19.0	19.0	18.0	15.5	12.0	8.5		200
205	19.0	19.0	18.0	15.5	12.0	8.5		205
210	19.0	19.0	18.0	15.5	12.0	8.5		210
215	19.0	19.0	18.0	15.5	12.0	8.5		215
220	19.0	19.0	18.0	15.5	12.0	8.5		220
225	19.0	19.0	18.0	15.5	12.0	8.5		225
230	19.0	19.0	18.0	15.5	12.0	8.5		230
T1	0	50	50	100	100	100	100	T1
T2	0	0	50	50	100	100	100	T2
T3	0	0	0	0	0	50	100	T3

*1000 lbs

Main boom + luffing fly jib

Lifting capacities in 1000 lbs

MAIN BOOM AT 65° ANGLE



69 ft



360°

Counterweight

198,4*

lbs

Radius ft	Main boom length at 65°							Radius ft
	53 ft	71 ft	89 ft	107 ft	125 ft	143 ft	161 ft	
65	136.0	132.0						65
70	126.0	120.0						70
75	115.0	108.0						75
80	105.0	99.7	93.1					80
85	97.5	93.0	86.3	83.7				85
90		86.2	81.2	77.4				90
95			76.2	71.8	67.3			95
100				67.2	62.8	52.3		100
105				63.9	59.5	50.7	39.6	105
110					56.1	47.3	39.6	110
115						44.0	38.5	115
120							37.4	120
125							37.3	125
130							35.7	130
T1	0	50	100	100	100	100	100	T1
T2	0	0	0	50	100	100	100	T2
T3	0	0	0	0	0	50	100	T3

92 ft

360°

Counterweight

198,4*

lbs

Radius ft	Main boom length at 65°							Radius ft
	53 ft	71 ft	89 ft	107 ft	125 ft	143 ft	161 ft	
75	113.0							75
80	103.0							80
85	95.3	90.3						85
90	90.0	84.0						90
95	83.9	78.4	74.0					95
100	77.7	73.3	69.4	65.0				100
105	72.7	68.3	66.1	61.7	57.3			105
110		64.9	62.7	58.3	53.9			110
115			58.2	55.0	50.5			115
120				51.6	47.3	43.4		120
125				48.2	46.1	41.7	33.0	125
130					44.5	40.1	33.0	130
135					41.5	38.4	31.8	135
140						36.0	30.8	140
145						32.6	30.6	145
150							28.9	150
T1	0	50	100	100	100	100	100	T1
T2	0	0	0	50	100	100	100	T2
T3	0	0	0	0	0	50	100	T3

115 ft

360°

Counterweight

198,4*

lbs

Radius ft	Main boom length at 65°							Radius ft
	53 ft	71 ft	89 ft	107 ft	125 ft	143 ft	161 ft	
100	77.7							100
105	72.7	77.1						105
110	69.3	65.3						110
115	66.0	59.4	58.2					115
120	62.6	56.0	54.4	49.4				120
125	59.3	52.6	52.6	46.1	46.1			125
130		49.3	49.3	44.5	44.5			130
135		47.2	47.2	41.5	41.5			135
140			44.8	38.9	38.9	32.3		140
145			41.4	37.2	37.2	30.8	24.2	145
150				35.5	35.5	30.8	24.2	150
155					33.9	29.4	24.2	155
160						27.8	24.2	160
165						26.1	24.2	165
170							24.2	170
T1	0	50	100	100	100	100	100	T1
T2	0	0	0	50	100	100	100	T2
T3	0	0	0	0	0	50	100	T3

*1000 lbs



KMK 8400

Main boom + luffing fly jib

Lifting capacities in 1000 lbs



138 ft



360°

198,4*

Counterweight lbs

Radius ft	Main boom length at 65°							Radius ft
	53 ft	71 ft	89 ft	107 ft	125 ft	143 ft	161 ft	
120	62.6							120
125	59.3	52.6						125
130	55.9	49.3						130
135	52.5	47.2	47.2					135
140	49.9	45.5	44.8	38.9				140
145	48.2	43.6	41.6	37.2	37.2			145
150	46.6	40.3	39.9	35.5	35.5	30.8		150
155		38.3	38.3	33.9	33.9	29.4		155
160			36.6	32.2	32.2	27.8	19.8	160
165			34.9	30.5	30.5	26.4	19.5	165
170				28.9	28.8	26.4	17.8	170
175				27.1	28.6	24.9	17.6	175
180					27.7	23.3	17.6	180
185						21.6	17.2	185
190						19.9	15.5	190
195							15.4	195
T1	0	50	100	100	100	100	100	T1
T2	0	0	0	50	100	100	100	T2
T3	0	0	0	0	0	50	100	T3

*1000 lbs



161 ft



360°

198,4*

Counterweight lbs

Radius ft	Main boom length at 65°							Radius ft
	53 ft	71 ft	89 ft	107 ft	125 ft	143 ft	161 ft	
140	49.2							140
145	46.0	41.6						145
150	44.4	39.9	39.6					150
155	42.7	38.3	38.3					155
160	41.0	36.6	35.7	30.0				160
165	39.3	34.9	32.7	28.3	28.3			165
170	37.6	33.2	31.0	26.6	26.6	22.0	13.2	170
175	36.0	31.5	30.8	24.9	26.4	22.0	13.2	175
180		29.9	29.9	24.2	25.5	22.0	12.2	180
185			28.3	24.2	24.2	21.6	11.0	185
190			26.5	24.2	24.2	19.9	11.0	190
195				22.6	22.6	19.8	11.0	195
200					20.9	18.7	11.0	200
205						17.6	11.0	205
210						17.6	11.0	210
215							11.0	215
T1	0	50	100	100	100	100	100	T1
T2	0	0	0	50	100	100	100	T2
T3	0	0	0	0	0	50	100	T3

*1000 lbs

Main boom + luffing fly jib

Lifting capacities in 1000 lbs



184 ft



360°

Counterweight

198,4*

lbs

Radius ft	Main boom length at 65°							Radius ft
	53 ft	71 ft	89 ft	107 ft	125 ft	143 ft	161 ft	
145	43.8							145
150	42.2	35.2						150
155	40.5	33.9						155
160	38.8	32.2	33.5					160
165	37.1	30.8	30.5	26.1				165
170	35.4	30.8	28.8	24.4	26.4			170
175	33.8	29.3	28.6	22.7	24.9			175
180	32.1	27.7	27.7	22.0	23.3	16.6		180
185	30.4	26.4	26.0	22.0	22.0	15.4	11.0	185
190	28.7	26.4	24.3	22.0	22.0	15.4	11.0	190
195	27.0	24.8	24.2	20.4	20.4	13.8	11.0	195
200		23.1	23.1	19.8	18.7	13.2	11.0	200
205		22.0	21.5	19.3	17.6	13.2	10.4	205
210		22.0	19.8	17.6	17.6	13.2	8.8	210
215			19.8	17.6	17.6	13.2	8.8	215
220				16.4	16.4	13.2	8.8	220
225					14.7	12.5	8.8	225
230					13.1	11.0	8.8	230
235						11.0	8.8	235
240							8.8	240
T1	0	50	100	100	100	100	100	T1
T2	0	0	0	50	100	100	100	T2
T3	0	0	0	0	0	50	100	T3

*1000 lbs



207 ft



360°

Counterweight

198,4*

lbs

Radius ft	Main boom length at 65°							Radius ft
	53 ft	71 ft	89 ft	107 ft	125 ft	143 ft	161 ft	
160	33.0							160
165	33.0	28.6						165
170	33.0	28.6	28.6					170
175	31.5	27.1	28.6					175
180	30.8	26.4	27.7	22.0				180
185	30.4	26.4	26.0	21.6	17.6			185
190	28.7	26.4	24.3	19.9	17.6	11.0		190
195	28.6	24.8	24.2	19.8	17.6	11.0		195
200	27.6	23.1	23.1	19.8	17.6	11.0	6.6	200
205	26.4	22.0	21.5	19.3	17.6	11.0	6.6	205
210	26.4	22.0	19.8	17.6	17.6	11.0	6.6	210
215	24.7	20.3	19.8	17.6	17.6	11.0	6.6	215
220	23.0	19.8	19.8	16.4	16.4	11.0	6.6	220
225		19.2	19.2	15.4	14.7	11.0	6.6	225
230		17.5	17.5	15.3	13.2	10.9	6.6	230
235			15.8	13.6	13.2	9.2	6.6	235
240				13.2	11.9	8.8	6.6	240
245					11.0	8.8	6.6	245
250					11.0	8.8	6.6	250
255						8.8	6.6	255
260							6.6	260
T1	0	50	100	100	100	100	100	T1
T2	0	0	0	50	100	100	100	T2
T3	0	0	0	0	0	50	100	T3

*1000 lbs

Main boom + luffing fly jib

Lifting capacities in 1000 lbs



230 ft



360°

198,4*

Counterweight lbs

Radius ft	Main boom length at 65°							Radius ft
	53 ft	71 ft	89 ft	107 ft	125 ft	143 ft	161 ft	
170	26.4							170
175	24.9							175
180	24.2	22.0						180
185	24.2	22.0	19.8					185
190	24.2	22.0	19.8	17.6				190
195	22.6	20.4	19.8	17.6				195
200	22.0	19.8	18.7	16.5	13.2			200
205	21.5	19.3	17.6	15.4	13.2	8.8		205
210	19.8	17.6	17.6	15.4	13.2	8.8	4.4	210
215	19.8	17.6	17.6	15.4	13.2	8.8	4.4	215
220	18.6	17.6	16.4	14.2	13.2	8.8	4.4	220
225	17.0	17.0	15.4	13.2	13.2	8.8	4.4	225
230	15.4	15.4	15.4	13.2	13.1	8.8	4.4	230
235	15.4	15.4	15.4	13.2	11.4	8.8	4.4	235
240	15.4	15.4	14.1	11.9	11.0	8.8	4.4	240
245		15.4	13.2	11.0	11.0	8.8	4.4	245
250		15.2	13.2	11.0	10.8	8.6	4.4	250
255		13.5	13.2	11.0	9.1	6.9	4.4	255
260			11.8	9.6	8.8	6.6	4.4	260
265				8.8	7.9	6.6	4.4	265
270				8.8	6.6	6.6	4.4	270
275					6.6	6.6	4.4	275
280						5.1	4.4	280
285							4.4	285
T 1	0	50	100	100	100	100	100	T 1
T 2	0	0	0	50	100	100	100	T 2
T 3	0	0	0	0	0	50	100	T 3

*1000 lbs



Telescopic boom



On outriggers



Working range

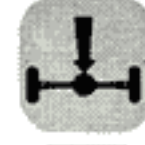

Axle load



Hook blocks and hook



Crane movements















Speed



Luffing jib/
lattice extension

KRUPP Hydraulic Mobile Cranes

Product Range

Truck Cranes	Max. lifting capacity	Max. hook height
KMK 5120 	120 ton	220 ft*
KMK 6250 	250 ton	320 ft*
KMK 8450 	450 ton	365 ft*
KMK 8500 	500 ton	390 ft*
KMK 11000 	1000 ton	440 ft*
All-Terrain Cranes		
KMK 2025 	25 ton	122 ft
KMK 2035 	35 ton	129 ft
KMK 3045 	45 ton	148 ft
KMK 4065 	65 ton	167 ft
KMK 4080 	80 ton	178 ft
KMK 5110 	110 ton	227 ft
KMK 6175 	175 ton	270 ft*
KMK 6275 	275 ton	350 ft*

* incl. power lifting jib

Subject to technical modifications without notice



KRUPP INDUSTRIES, INC. Construction Equipment Group
210 VANDALE DRIVE • HOUSTON, PA 15342
PHONE: 412-746-9360 • TELEFAX: 412-746-9350